

Chapter 18:

Stacks And Queues

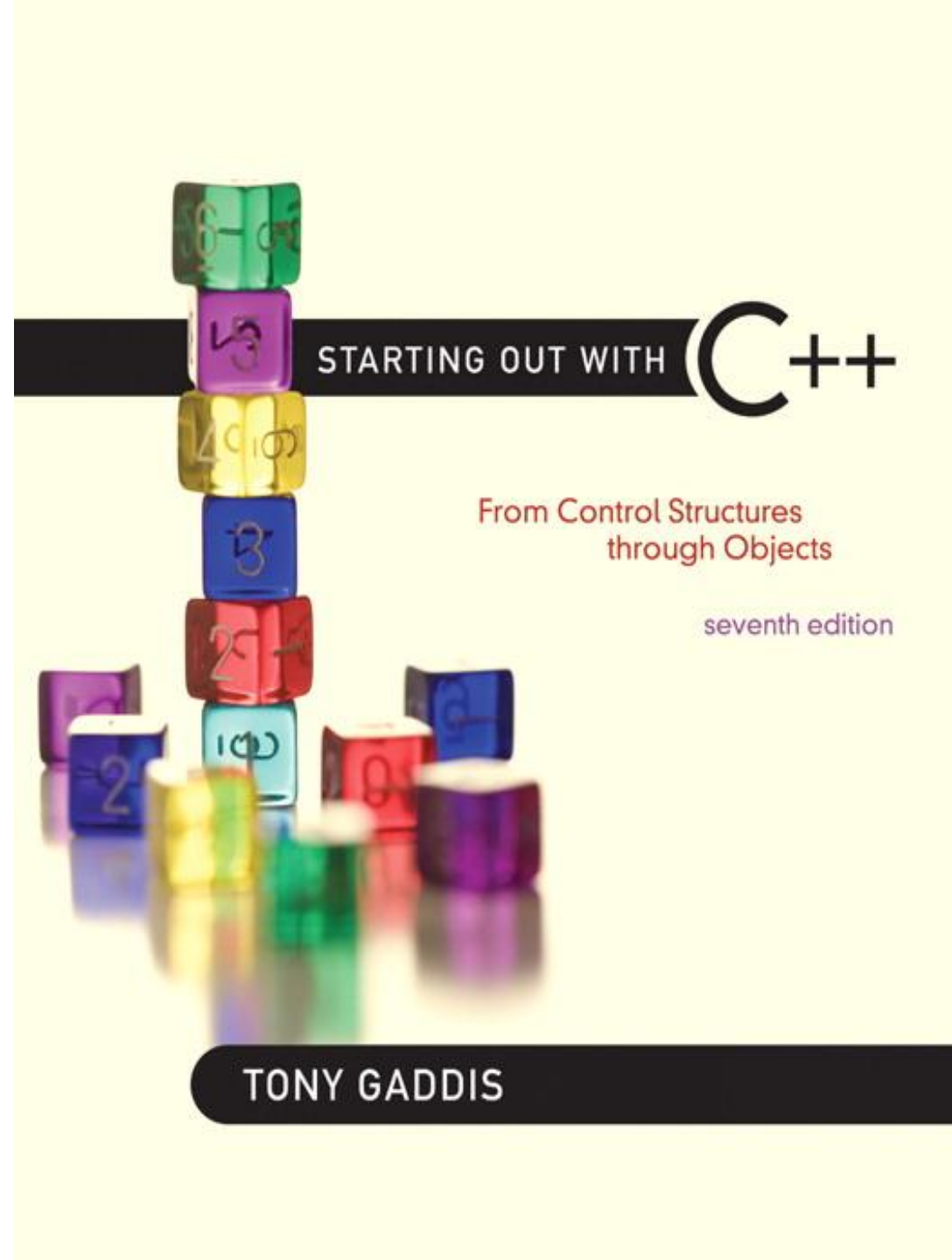

Addison-Wesley
is an imprint of

PEARSON

Copyright © 2012 Pearson Education, Inc.

18.1

Introduction to the Stack ADT

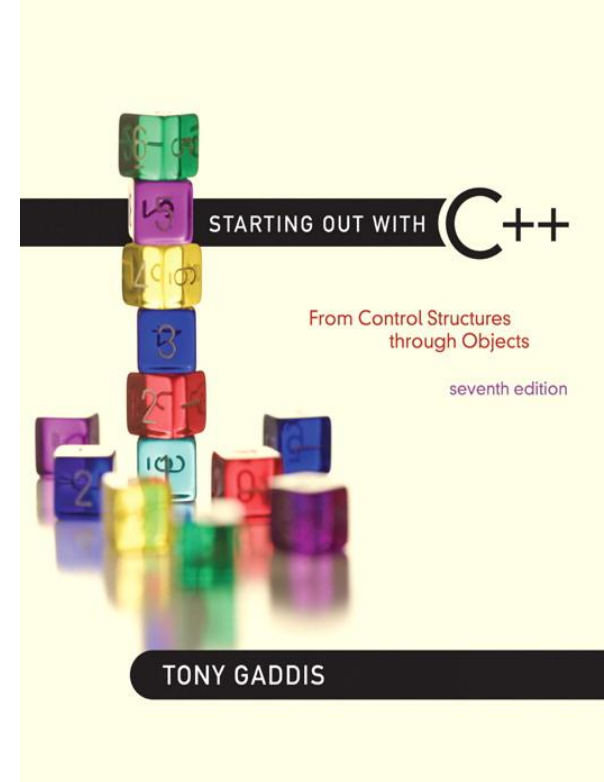

Introduction to the Stack ADT

- Stack: a LIFO (last in, first out) data structure
- Examples:
 - plates in a cafeteria
 - return addresses for function calls
- Implementation:
 - static: fixed size, implemented as array
 - dynamic: variable size, implemented as linked list

A LIFO Structure

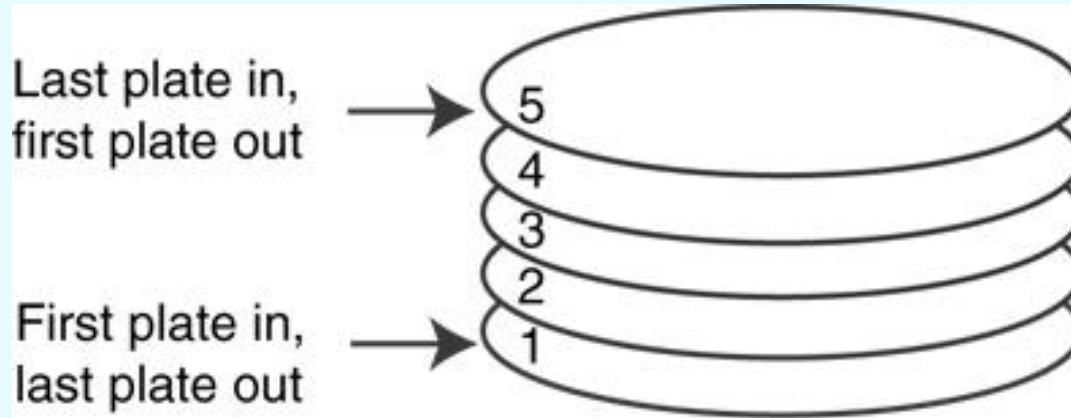

Stack Operations and Functions

- Operations:
 - push: add a value onto the top of the stack
 - pop: remove a value from the top of the stack
- Functions:
 - `isFull`: `true` if the stack is currently full, *i.e.*, has no more space to hold additional elements
 - `isEmpty`: `true` if the stack currently contains no elements

Stack Operations - Example

- A stack that can hold `char` values:

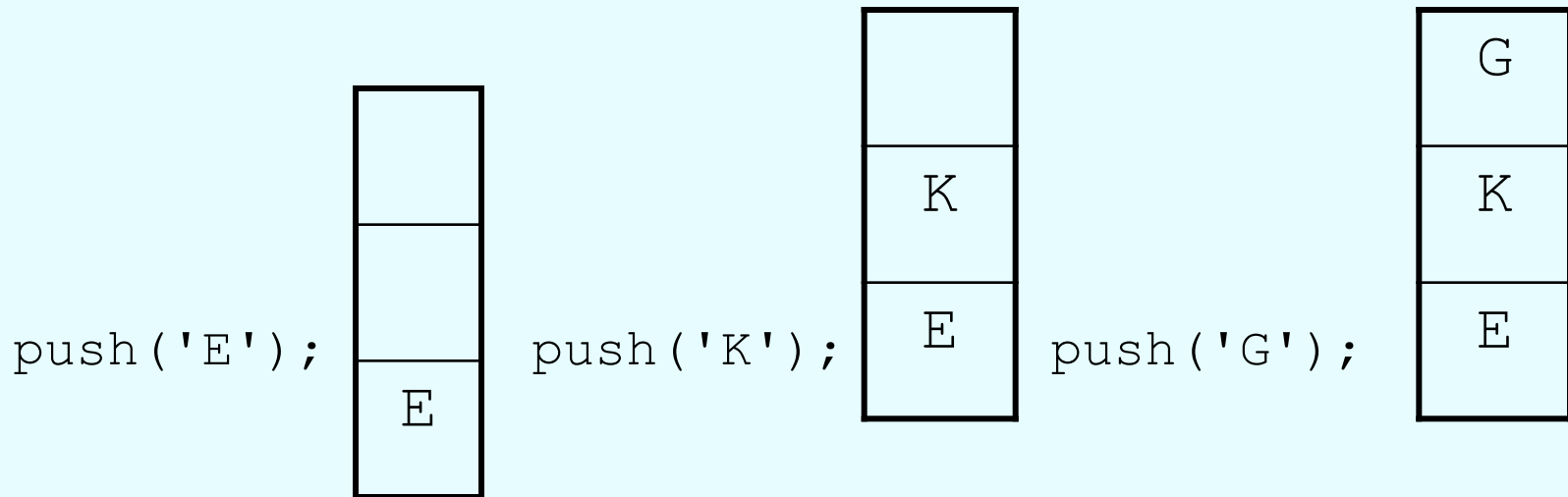

Stack Operations - Example

- A stack that can hold `char` values:

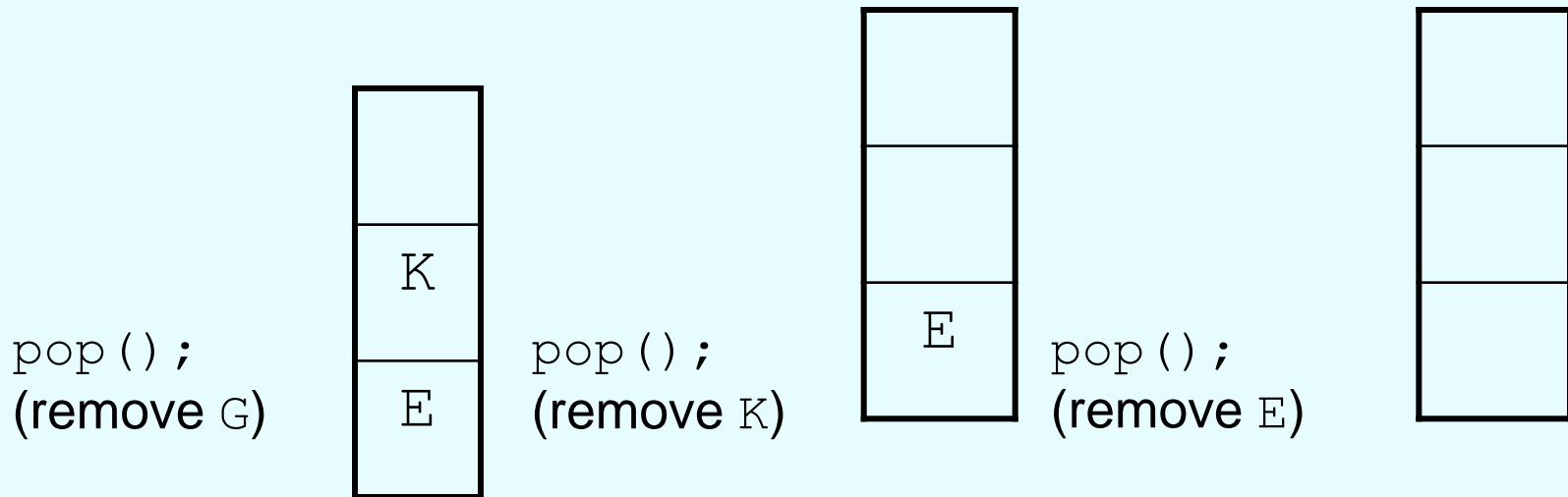

Contents of IntStack.h

```
1 // Specification file for the IntStack class
2 #ifndef INTSTACK_H
3 #define INTSTACK_H
4
5 class IntStack
6 {
7 private:
8     int *stackArray; // Pointer to the stack array
9     int stackSize;   // The stack size
10    int top;          // Indicates the top of the stack
11
12 public:
13     // Constructor
14     IntStack(int);
15
16     // Copy constructor
17     IntStack(const IntStack &);
18
19     // Destructor
20     ~IntStack();
21
22     // Stack operations
23     void push(int);
24     void pop(int &);
25     bool isFull() const;
26     bool isEmpty() const;
27 };
28 #endif
```

(See IntStack.cpp for the implementation.)

18.2

Dynamic Stacks

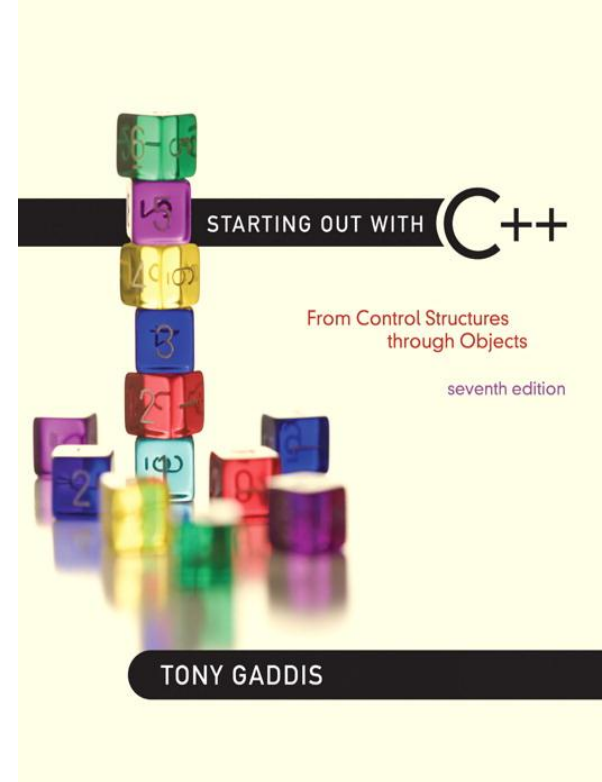

Dynamic Stacks

- Grow and shrink as necessary
- Can't ever be full as long as memory is available
- Implemented as a linked list

Implementing a Stack

- Programmers can program their own routines to implement stack functions
- **See** `DynIntStack` class in the book for an example.
- Can also use the implementation of stack available in the STL

18.3

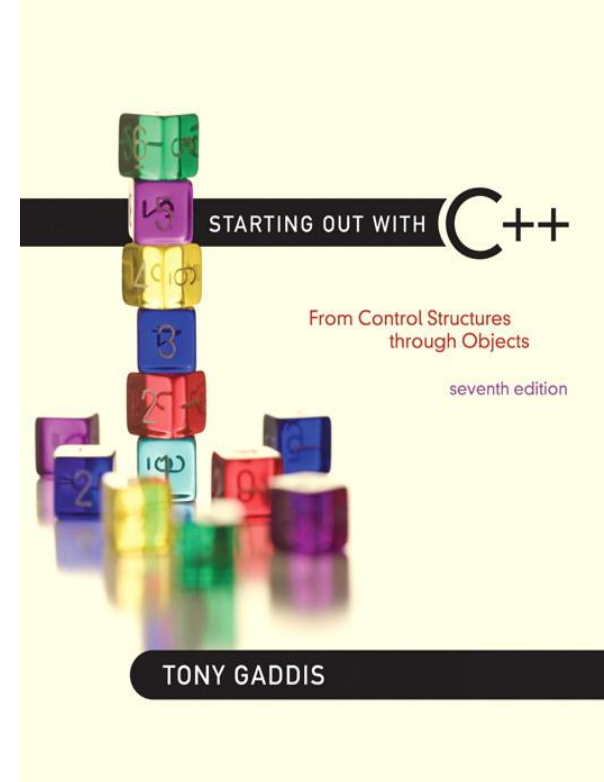

The STL `stack` Container

The STL `stack` container

- Stack template can be implemented as a `vector`, a linked list, or a `deque`
- Implements `push`, `pop`, and `empty` member functions
- Implements other member functions:
 - `size`: number of elements on the stack
 - `top`: reference to element on top of the stack

Defining a stack

- Defining a stack of chars, named `cstack`, implemented using a vector:
`stack< char, vector<char> > cstack;`
- implemented using a list:
`stack< char, list<char> > cstack;`
- implemented using a deque:
`stack< char > cstack;`
- Spaces are required between consecutive `>>`, `<<` symbols

18.4

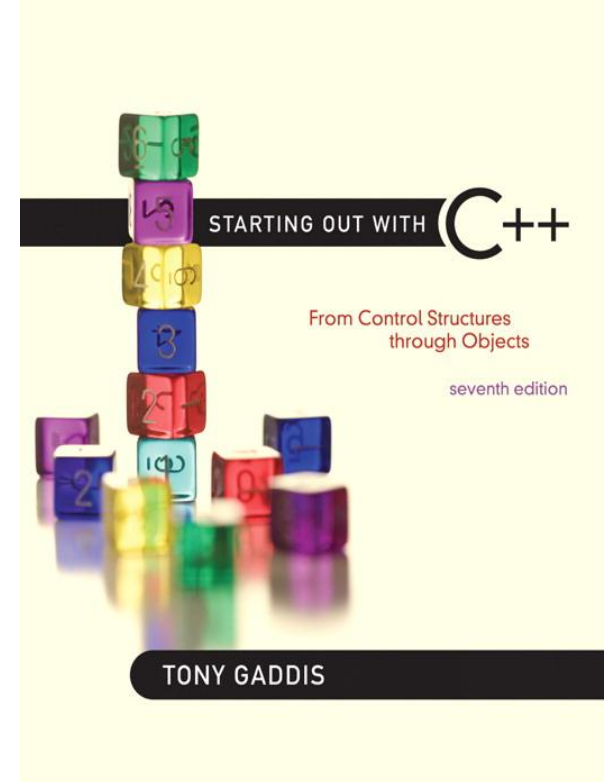

Introduction to the Queue ADT

Introduction to the Queue ADT

- Queue: a FIFO (first in, first out) data structure.
- Examples:
 - people in line at the theatre box office
 - print jobs sent to a printer
- Implementation:
 - static: fixed size, implemented as array
 - dynamic: variable size, implemented as linked list

Queue Locations and Operations

- rear: position where elements are added
- front: position from which elements are removed
- enqueue: add an element to the rear of the queue
- dequeue: remove an element from the front of a queue

Queue Operations - Example

- A currently empty queue that can hold `char` values:



- `enqueue('E');`

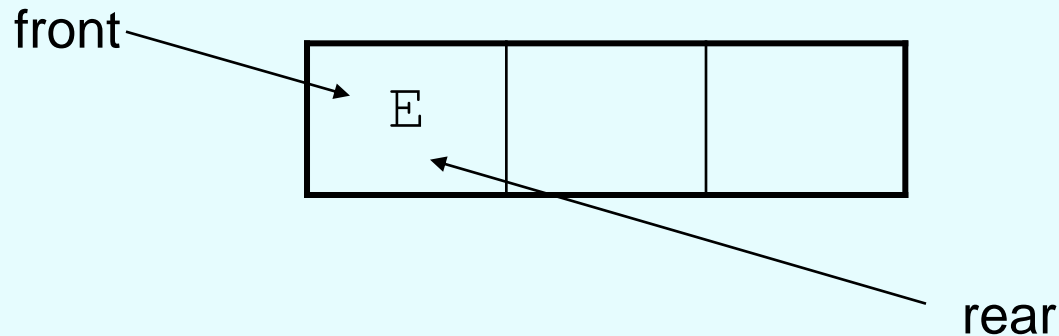

Queue Operations - Example

- `enqueue ('K') ;`

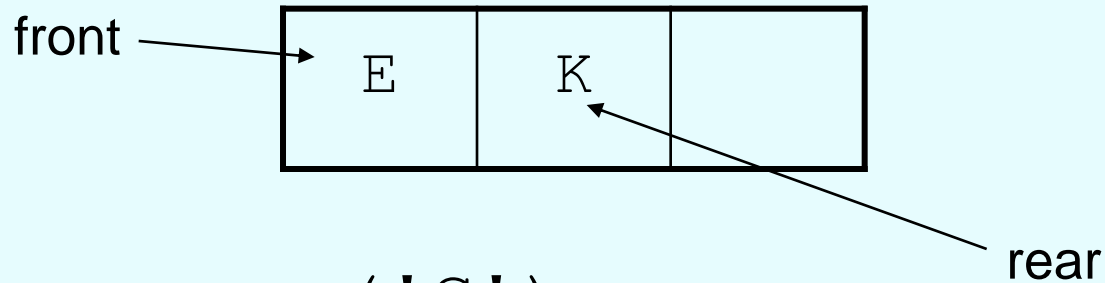

- `enqueue ('G') ;`

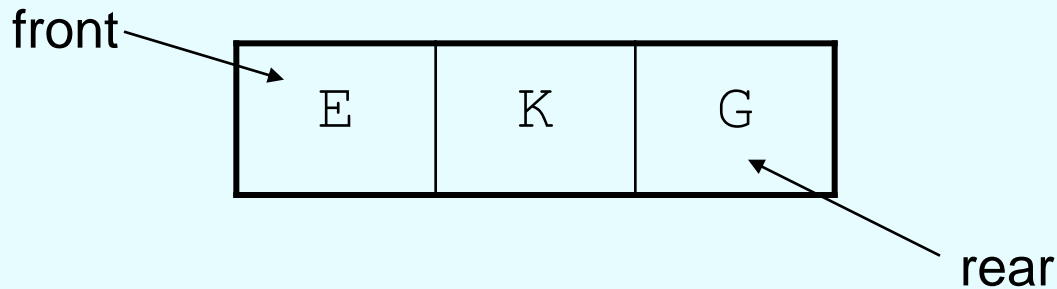

Queue Operations - Example

- `dequeue(); // remove E`

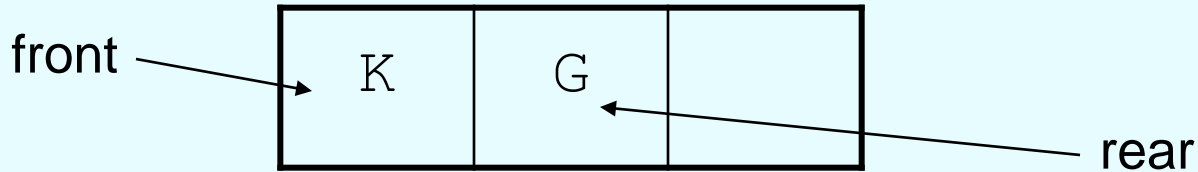

- `dequeue(); // remove K`

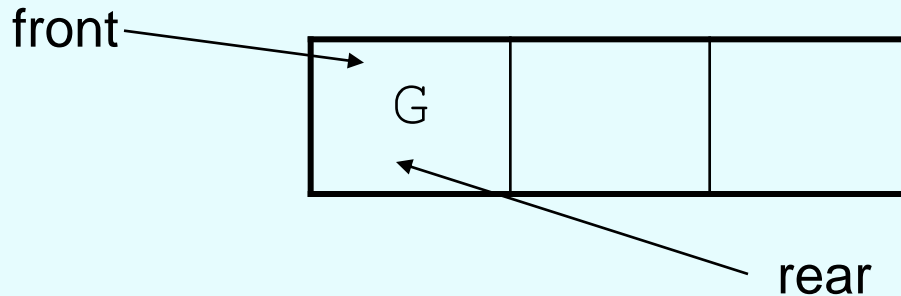

dequeue Issue, Solutions

- When removing an element from a queue, remaining elements must shift to front
- Solutions:
 - Let front index move as elements are removed (works as long as rear index is not at end of array)
 - Use above solution, and also let rear index "wrap around" to front of array, treating array as circular instead of linear (more complex enqueue, dequeue code)

Contents of IntQueue.h

```
1 // Specification file for the IntQueue class
2 #ifndef INTQUEUE_H
3 #define INTQUEUE_H
4
5 class IntQueue
6 {
7 private:
8     int *queueArray; // Points to the queue array
9     int queueSize; // The queue size
10    int front; // Subscript of the queue front
11    int rear; // Subscript of the queue rear
12    int numItems; // Number of items in the queue
```

Contents of IntQueue.h (Continued)

```
13 public:
14     // Constructor
15     IntQueue(int);
16
17     // Copy constructor
18     IntQueue(const IntQueue &);
19
20     // Destructor
21     ~IntQueue();
22
23     // Queue operations
24     void enqueue(int);
25     void dequeue(int &);
26     bool isEmpty() const;
27     bool isFull() const;
28     void clear();
29 };
30 #endif
```

(See IntQueue.cpp for the
implementation)

18.5

Dynamic Queues

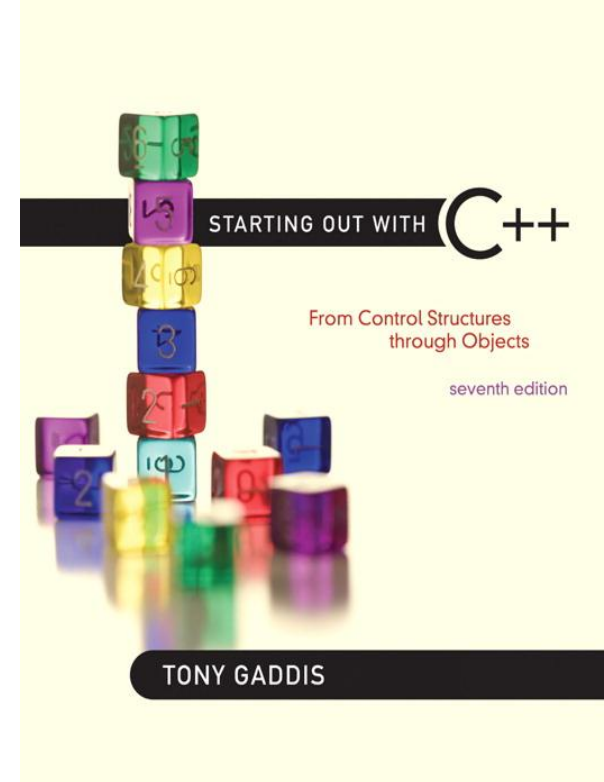

Dynamic Queues

- Like a stack, a queue can be implemented using a linked list
- Allows dynamic sizing, avoids issue of shifting elements or wrapping indices

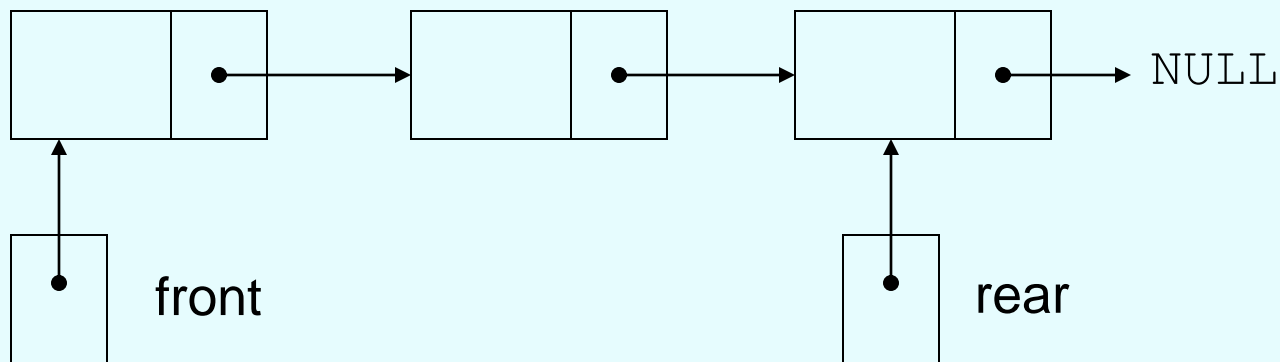

Implementing a Queue

- Programmers can program their own routines to implement queue operations
- See the `DynIntQue` class in the book for an example of a dynamic queue
- Can also use the implementation of `queue` and `dequeue` available in the STL

18.6

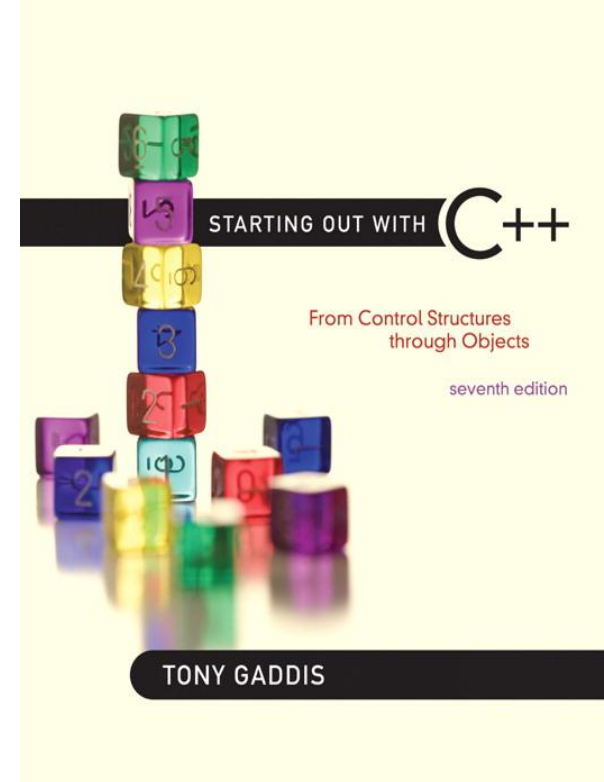

The STL deque and queue Containers

The STL deque and queue Containers

- `deque`: a double-ended queue. Has member functions to enqueue (`push_back`) and dequeue (`pop_front`)
- `queue`: container ADT that can be used to provide queue as a `vector`, `list`, or `deque`. Has member functions to enqueue (`push`) and dequeue (`pop`)

Defining a queue

- Defining a queue of `char`s, named `cQueue`, implemented using a deque:
`deque<char> cQueue;`
- implemented using a queue:
`queue<char> cQueue;`
- implemented using a list:
`queue< char, list<char> > cQueue;`
- Spaces are required between consecutive `>>`, `<<` symbols